



-  109
-  103
-  104
-  102



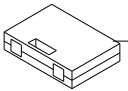

A-2211

POS.	OMSCHRIJVING	ONDERDEELNR
1	KOOLBORSTELDOP	XAM-N14022
2	STELSCHROEF M5x10	XAM-FIK051
3	ZELFTAPPENDE SCHROEF	XAM-FF1410
4	LUCHTRING	XAM-N14010
5	LAGER BESCHERMKAP	XAM-N14011
6	MOTORHUIS 2200W CARAT	XAM-N20017/22
7	VELD 2200W	XAM-N20013/22
8	KOOLBORSTELHOUDER	XAM-N14020
9	KOOLBORSTELSET A-20..	XAM-N14058
10	HANDGR.DEEL RECHTS ACHTER 2211	XAM-N20020
11	HANDGR.DEEL LINKS ACHTER 2211	XAM-N20021
12	SOFT-GRIP	XAM-N20019
13	PRINTPLAAT COMPL. 2200W ACHTER	XAM-N20018/22
14	SCHAKELAAR 10A "SPECIAAL"	XAM-N200305
15	CONDENSATOR INCL. FASTONS	XAM-N20022
16	LED	XAM-N14032
17	LIBELLE CILINDERVORMIG	XAM-N14034
18	LIBELLE ROND	XAM-N14035
19	KABELTULE	XAM-N14023
20	KABELKLEM	XAM-N14024
21	SCHROEF 3,5x16 ZELFTAPPEND	XAM-N14039
22	SCHROEF 4,0x20 ZELFTAPPEND	XAM-N14040
23	PANCLINDERSCHROEF 4,8x32	XAM-FF1432
24	TANDVEERRING M4	XAM-FV04TV
25	VERZONKEN SCHROEF 3,5x8	XAM-FQ2408
26	AANSLUITSNØER COMPLEET 230V	XAM-N20050
27	KOGELLAGER 629	XAM-EA007D
28	SHIMRING 10x16mm	XAM-FS10P2
29	ANKER 2200W	XAM-N20014/22
30	ANKERTANDWIEL	XAM-N20005
31	KOGELLAGER 6202	XAM-EA028F
32	DEKSEL VERSNELLINGSBAK CARAT	XAM-N20015
33	AARDEKABEL	XAM-N20023
34	KEERRING 12x22x4	XAM-E30A05
35	O-RING 35x1,5	XAM-E4035A
36	PASPEN 4x12	XAM-F6Q112
37	O-RING 85x2,0	XAM-E4084A
38	NAALDHUIS 1010	XAM-EB012A
39	NAALDHUIS 1010	XAM-EB012B
40	CILINDERSCHROEF M4x10	XAM-FZ4110
41	VERSNELLINGSBAK CARAT	XAM-N20001
42	HOOFDAS	XAM-N20002
43	TANDWIEL	XAM-N20003
44	TANDWIEL	XAM-N20004
45	TANDWIEL	XAM-N20006
46	KOGELLAGER 6005	XAM-EA050A
47	SEEGERRING 25mm	XAM-FR0250
48	SPIE 6X6X40	XAM-F6R340
49	PASPEN 5x14	XAM-F6PG14
50	KEERRING 22X35X5	XAM-E32030
51	SHIMRING 18X25	XAM-FS18P2
52	SEEGERRING 18MM	XAM-FR0180
53	SHIMRING 14x20	XAM-FS14P2
54	CIRCLIP A-2211	XAM-FR4140
55	PANCLINDERSCHROEF 4,8x50	XAM-FF1450
56	NAALDLAGER 0910	XAM-EB009A
57	NAALDLAGER 917	XAM-EN0109
58	LOOPRING 917	XAM-EN01091
59	TYPEPLAATJE A-2211	XAM-N20223
60	SCHAKELKNOP ASSEMBLY 2000	XAM-N18006C2

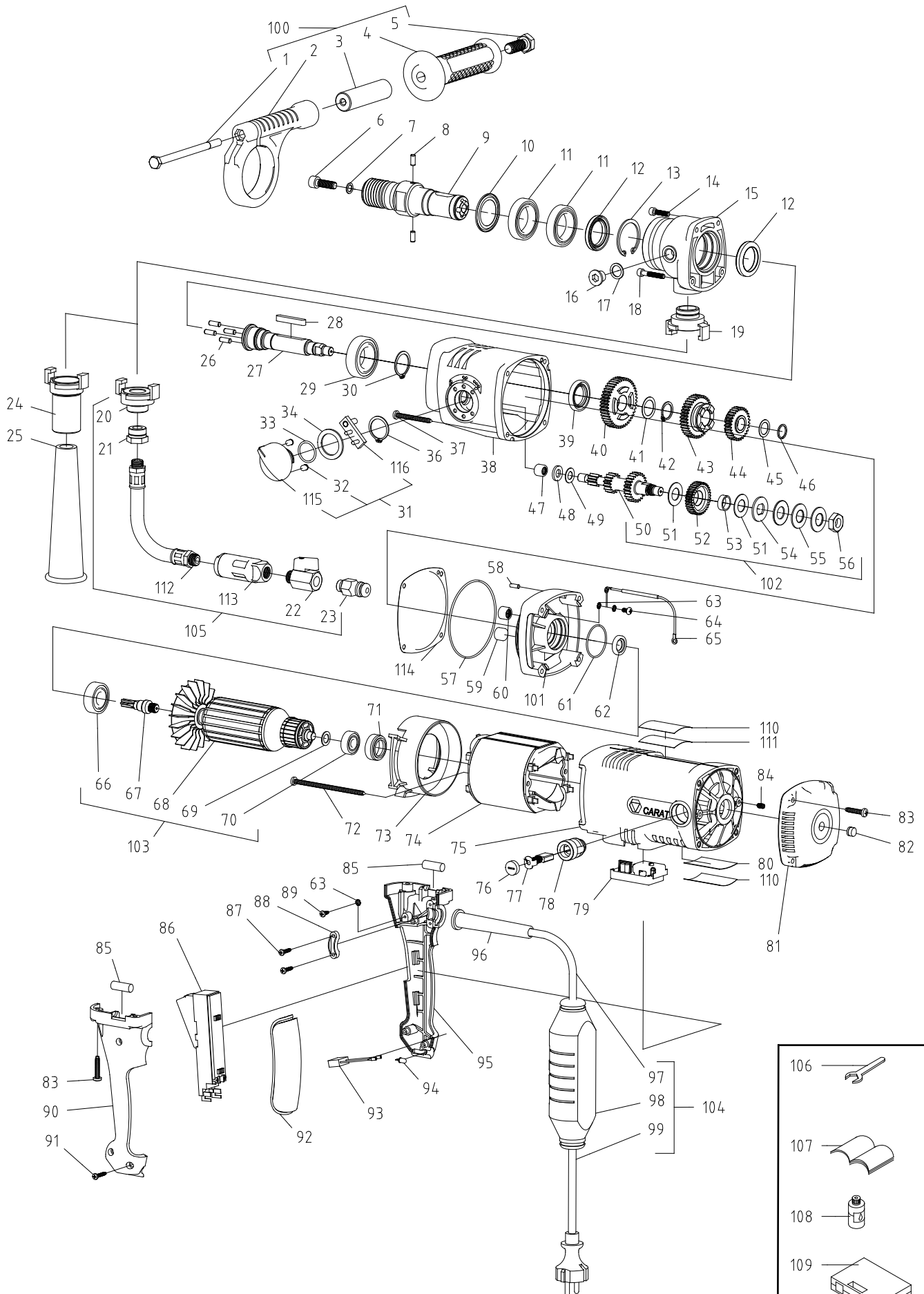
62	SEEGERRING 24mm	XAM-FR0240
63	O-RING 21x2,0	XAM-E4021B
64	DRUKSTUK ROND 6	XAM-F42605
65	SHIMRING 25x35	XAM-FS25P2
66	ASHUIS	XAM-N18022
67	KEERRING 28x40x6	XAM-E30A28
68	SEEGERRING 40mm	XAM-FR1400
69	KOGELLAGER 61906	XAM-EA057A
70	LAGERRING 61906	XAM-EXR100
71	HOOFDAS 5/4" - 1/2"	XAM-N18030
72	ROODKOPEREN RING 8x12MM	XAM-903740
73	CILINDERKOPBOUT M8x25	XAM-FBC025
74	CILINDERKOPBOUT BZK M5x30	XAM-FBC730
75	CILINDERKOPBOUT BZK M5x20	XAM-FBC720
76	PASPEN 5X12	XAM-F6PG12
77	LAMINAAT STICKER TBV TYPEPLAAT	XAM-N140281
78	STOP G1/4"	XAM-F45625
79	KOPPELING G3/4"BU	XAM-F43282
80	TULE 5/4"	XAM-F43283
81	TULE AFZUIGING	XAM-N18045
82	KOPPELING G1/2"BI	XAM-F43281
83	VERLOOP 1/2"BU - 1/4"BI	XAM-F45560
84	KLEMRING	XAM-N18032
85	STANG ZIJHANDGREEP	XAM-N18033
86	HANDVAT ZIJHANDGREEP	XAM-N14027
87	ZESKANT BOUT M8X120	XAM-FC0820
88	ZESKANTBOUT M12X30	XAM-FB2030
89	TANDWIEL AS	XAM-N20007
90	SLIPRING	XAM-N20009
91	LAGERBUS	XAM-N20010
92	BORGRING	XAM-N20011
93	SLIPTANDWIEL	XAM-N20008
94	VEERRING TBV AM-2211	XAM-FR6280
95	ZESKANTMOER M12	XAM-N20012
96	SLIPKOPPELING COMPLEET	XAM-N20041
97	HANDGREEP COMPLEET	XAM-N20042
98	ANKER COMPLEET 2200W	XAM-N20038/22
99	KABEL 3,5MTR + STEKKER	XAM-N18050
100	PRCD-SCHAKELAAR	BA08000000
101	AANSLUITSNØER PRCD --> MOTOR	XAM-N20051
102	ALUMINIUM KOFFER	ZVMKA20110
103	GEbruiksaanwijzing A-2211	XAM-N20062
104	OLIE VERSNELLINGSBAK 2000W	XAM-N20045
105	RING 13x18x1	XAM-F43350
106	KOGELKRAAN	ZZ-KK02500
107	GARDENA TULE MESSING	XAM-F20150
108	WATERKRAANSET COMPLEET	XAM-N18199
109	STEEKSLEUTEL 32	ZZ-SS32000
110	WAARSCHUWINGSSTICKER	XAM-N140282
111	WATERSLANG	XAM-N14081
112	FLOWMETER	XAM-N14082
113	PAKKING TBV A14../A18../A20..	XAM-N14096
114	VERSNELLINGSHENDEL	XAM-N20016A
115	SCHAKELAARKNOP	XAM-N18006A

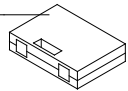

- 106 
- 107 
- 108 
- 109 

POS.	OMSCHRIJVING	ONDERDEELNR
1	ZESKANT BOUT M8X120	XAM-FC0820
2	KLEMRING	XAM-N18032
3	STANG ZIJHANDGREEP	XAM-N18033
4	HANDVAT ZIJHANDGREEP	XAM-N14027
5	ZESKANTBOUT M12X30	XAM-FB2030
6	CILINDERKOPBOUT M8x25	XAM-FBC025
7	ROODKOPEREN RING 8x12MM	XAM-903740
8	PASPEN 5X12	XAM-F6PG12
9	HOOFDAS 5/4" - 1/2"	XAM-N18030
10	LAGERRING 61906	XAM-EXR100
11	KOGELLAGER 61906	XAM-EA057A
12	KEERRING 28x40x6	XAM-E30A28
13	SEEGERRING 40mm	XAM-FR1400
14	CILINDERKOPBOUT BZK M5x20	XAM-FBC720
15	ASHUIS	XAM-N18022
16	STOP G1/4"	XAM-F45625
17	RING 13x18x1	XAM-F43350
18	CILINDERKOPBOUT BZK M5x30	XAM-FBC730
19	KOPPELING G3/4"BU	XAM-F43282
20	KOPPELING G1/2"BI	XAM-F43281
21	VERLOOP 1/2"BU - 1/4"BI	XAM-F45560
22	KOGELKRAAN	ZZ-KK02500
23	GARDENA TULE MESSING	XAM-F20150
24	TULE 5/4"	XAM-F43283
25	TULE AFZUIGING	XAM-N18045
26	PASPEN 5x14	XAM-F6PG14
27	HOOFDAS	XAM-N20002
28	SPIE 6X6X40	XAM-F6R340
29	KOGELLAGER 6005	XAM-EA050A
30	SEEGERRING 25mm	XAM-FR0250
31	SCHAKELKNOP ASSEMBLY 2000	XAM-N18006C2
32	DRUKSTUK ROND 6	XAM-F42605
33	O-RING 21x2,0	XAM-E4021B
34	SHIMRING 25x35	XAM-FS25P2
36	SEEGERRING 24mm	XAM-FR0240
37	PANCILINDERSCHROEF 4,8x50	XAM-FF1450
38	VERSNELLINGSBAK CARAT	XAM-N20001
39	KEERRING 22X35X5	XAM-E32030
40	TANDWIEL	XAM-N20003
41	SHIMRING 18X25	XAM-FS18P2
42	SEEGERRING 18MM	XAM-FR0180
43	TANDWIEL	XAM-N20004
44	TANDWIEL	XAM-N20006
45	SHIMRING 14x20	XAM-FS14P2
46	CIRCLIP A-2211	XAM-FR4140
47	NAALDLAGER 0910	XAM-EB009A
48	NAALDLAGER 917	XAM-EN0109
49	LOOPRING 917	XAM-EN01091
50	TANDWIEL AS	XAM-N20007
51	SLIPRING	XAM-N20009
52	SLIPTANDWIEL	XAM-N20008
53	LAGERBUS	XAM-N20010
54	BORGRING	XAM-N20011
55	VEERRING TBV A-2212	XAM-FR6280
56	ZESKANTMOER M12	XAM-N20012
57	O-RING 85x2,0	XAM-E4084A
58	PASPEN 4x12	XAM-F6Q112
59	NAALDHUIS 1010	XAM-EB012B
60	NAALDHUIS 1010	XAM-EB012A
61	O-RING 35x1,5	XAM-E4035A

62	KEERRING 12x22x4	XAM-E30A05
63	TANDVEERRING M4	XAM-FV04TV
64	CILINDERSCHROEF M4x10	XAM-FZ4110
65	AARDE KABEL ZIJ-HANDGREEP	XAM-N20040
66	KOGELLAGER 6202	XAM-EA028F
67	ANKERTANDWIEL	XAM-N20005
68	ANKER 2200W	XAM-N20014/22
69	SHIMRING 10x16mm	XAM-FS10P2
70	KOGELLAGER 629	XAM-EA007D
71	LAGER BESCHERMKAP	XAM-N14011
72	ZELFTAPPENDE SCHROEF	XAM-FF1410
73	LUCHTRING	XAM-N14010
74	VELD 2200W	XAM-N20013/22
75	MOTORHUIS 2200W ZIJ CARAT	XAM-N20046/22
76	KOOLBORSTELDOP	XAM-N14022
77	KOOLBORSTELSET A-20..	XAM-N14058
78	KOOLBORSTELHOUDER	XAM-N14020
79	ELECTRO-UNIT 2200W	XAM-N20028/22
80	TYPEPLAATJE A-2212	XAM-N20224
81	AFDEKPLAAT ACHTERZIJDE 2200W	XAM-N20026
82	LIBELLE ROND	XAM-N14035
83	PANCILINDERSCHROEF 4,8X25	XAM-FF1425
84	STELSCHROEF M5x10	XAM-FIK051
85	LIBELLE CILINDERVORMIG	XAM-N14034
86	SCHAKELAAR 10A "SPECIAAL"	XAM-N20030S
87	SCHROEF 3,5x16 ZELFTAPPEND	XAM-N14039
88	KABELKLEM	XAM-N14024
89	VERZONKEN SCHROEF 3,5x8	XAM-FQ2408
90	HANDGR.DEEL LINKS ZIJ 2212	XAM-N20035
91	SCHROEF 4,0x20 ZELFTAPPEND	XAM-N14040
92	SOFT-GRIP	XAM-N20019
93	CONDENSATOR INCLUSIEF FASTONS	XAM-N20044
94	LED	XAM-N14032
95	HANDGR.DEEL RECHTS ZIJ 2212	XAM-N20034
96	KABELTULE	XAM-N14023
97	KABEL 0,5 METER	XAM-N20037
98	PRCD-SCHAKELAAR	BA08000000
99	KABEL 3,5MTR + SCHUKO	XAM-N18050
100	HANDGREEP COMPLEET	XAM-N20042
101	DEKSEL VERSNELLINGSBAK CARAT	XAM-N20015
102	SLIPKOPPELING COMPLEET	XAM-N20041
103	ANKER COMPLEET 2200W	XAM-N20038/22
104	ELECTROKABEL+PRCD ZIJHANDGREEP	XAM-N20036
105	WATERKRAANSET COMPLEET	XAM-N18199
106	STEEKSLEUTEL 32	ZZ-SS32000
107	GEbruiksaanwijzing A-2212	XAM-N20064
108	OLIE VERSNELLINGSBAK 2000W	XAM-N20045
109	KUNSTSTOF KOFFER TBV A-2212	ZVMKA20120
110	LAMINAAT STICKER TBV TYPEPLAAT	XAM-N140281
111	WAARSCHUWINGSSTICKER	XAM-N140282
112	WATERSLANG	XAM-N14081
113	FLOWMETER	XAM-N14082
114	PAKKING TBV A14../A18../A20..	XAM-N14096
115	SCHAKELAARKNOP	XAM-N18006A
116	VERSNELLINGSHENDEL	XAM-N20016A